

Armoires universelles

Armoire d'atelier H.1950mm - P. 420 mm

Profondeur x largeur mm	420 x 920	420 x 1200
Poids	66 kg	74 kg
Gris clair	GV130 347	GV130 348
€/p	379	499
Tabl. Suppl en zinc (Emballé par 2 pièces)		
Réf.	GV130 926	GV130 927
€/set	39	55



Armoire d'atelier H.1950mm - P. 500 mm



Profondeur x largeur mm	500 x 920	500 x 1200
Poids	65 kg	81 kg
Gris clair	GV257 985	GV130 352
€/p	389	499
Tabl. Suppl en zinc (Emballé par 2 pièces)		
Réf.	GV257 986	GV130 929
€/set	35	75



Armoire d'atelier H. 1950mm - P.600 mm



Profondeur x largeur mm	600 x 920	600 x 1200
Poids	73 kg	87 kg
Gris clair	GV212 021	GV212 022
€/p	509	659
Tabl. Suppl en zinc (Emballé par 2 pièces)	-	
Réf.	GV212 168	GV212 169
€/set	65	75

Armoires Pro



Armoire d'atelier H 1950			
Largeur x Profondeur	950x600mm		950x600mm
Equipement : 4 tablettes réglables		Equipement : 2 tablettes réglables dos perforé (dessus)	
Code	SPD-11-A		SPD-11-B
Prix € Hors TVA	466,85		454,33

Largeur x Profondeur	950x600mm		950x600mm
Equipement : 1 tablette réglable 2 tiroirs H 100mm Dos perforé (dessus)		Equipement : 1 tablette réglable 3 tiroirs H 100mm Dos perforé (dessus)	
Code	SPD-11-C		SPD-11-D
Prix € Hors TVA	602,56		750,8

Largeur x Profondeur	950x600mm		505x600mm
Equipement : 8 tiroirs H100mm, Dos perforé (dessus)		Equipement : 4 tablettes réglables	
Code	SPD-11-E		SPD-13-A
Prix € Hors TVA	1.024,84		358,32

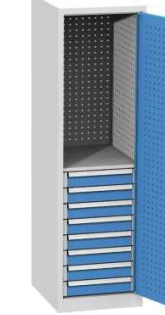
Armoires d'atelier H 1950mm			
Largeur x Profondeur	505x600mm		505x600mm
<p>Equipement :</p> <p>2 tablettes réglables</p> <p>dos perforé (dessus)</p>		<p>Equipement :</p> <p>1 tablette réglable</p> <p>2 tiroirs H 100mm</p> <p>Dos perforé (dessus)</p>	
Code	SPD-13-B		SPD-13-C
Prix € Hors TVA	362,4		456,95

Largeur x Profondeur	505x600mm		505x600mm
<p>Equipement :</p> <p>1 tablette réglable</p> <p>3 tiroirs H 100mm</p> <p>Dos perforé (dessus)</p>		<p>Equipement :</p> <p>8 tiroirs H100mm,</p> <p>Dos perforé (dessus)</p>	
Code	SPD-13-D		SPD-13-E
Prix € Hors TVA	538,79		685,72

Armoires d'ateliers H 1180mm			
Largeur x Profondeur	950x600mm		950x600mm
			
Code	SPD-12-A		SPD-12-B
Prix € Hors TVA	358,52		443,17









































Largeur x Profondeur	950x600mm
	
Code	SPD-12-C
Prix € Hors TVA	517,27

Options pour armoires d'ateliers Pro

	code	Prix € HTVA
Tablette supplémentaire pour armoire SPD-11-A	SPD-11-P1	22,44
Tablette supplémentaire pour armoires SPD-11-B, C, D et E	SPD-11-P2	22,44
Tablette supplémentaire pour armoire SPD-12-A	SPD-11-P1	22,44
Tablette supplémentaire pour armoires SPD-12B, C, D et E	SPD-11-P2	22,44
Tablette supplémentaire pour armoire SPD-13-A	SPD-13-P1	13,31
Tablette supplémentaire pour armoires SPD-13-B, C, D et E	SPD-13-P2	13,31

	Code	Prix € HTVA	Code	Prix € HTVA
Séparations pour tiroirs d'armoires largeur :	950mm		505mm	
4 casiers	VND-SPD-11	15,56	VND-SPD-14	14,60
9 casiers	VND-SPD-12	21,69	VND-SPD-15	21,17
12 casiers	VND-SPD-13	26,61	VND-SPD-16	24,92

Kits de crochets pour dos et portes perforées

Code set		QDN-50-01	QDN-50-02	QDN-50-03	QDN-50-04
Crochet simple 90° - 35mm		2		2	
Crochet simple 90° - 100mm					2
Crochet simple 90° - 150mm					2
Crochet double 90° - 35mm		2			
Crochet double 90° - 50mm		2		2	
Crochet double 90° - 100mm				2	2
Crochet double 90° - 150mm					2
Crochet simple 45° - 35mm				2	
Crochet simple 45° - 50mm		2			
Crochet simple 45° - 100mm				2	2
Crochet simple 45° - 150mm					2
Crochet double 45° - 50mm		2		2	
Crochet double 45° - 100mm				2	2
Crochet double 45° - 150mm					2
Crochet simple plat - 100mm				1	
Crochet simple plat - 150mm					2
Crochet double plat - 100mm				1	
Crochet double plat - 150mm					2
Support clé Allen		1			
Support douilles 1/4			1		
Support douilles 1/2		1			
Porte clés à cliquet		1			
Support limes		1			
Porte tournevis		1			
Support clés 1		1			
support clés 2		1			
Support clés 3		1			
Support clés 4		1			
Porte embouts			1		
Porte spray			1		
Support cable			1		
Support magnétique			1		
Boîte de rangement 30x150x80mm			1		
Porte bacs à bec - 100mm			1		
Porte bacs à bec - 300mm			1		
Crochet boucle 90° - 60mm				1	
Crochet boucle 90° - 110mm				1	
Crochet boucle 45° - 60mm		1		1	
Crochet boucle 45° - 110mm				1	
Crochet boucle plat - 60mm		1			
Crochet boucle plat - 110mm				1	
Prix € Hors TVA		54,09	27,27	50,01	44,03